



# YOUR KITCHEN DESIGNER

Candice Whitney  
877-573-0088 ext. 6639  
[cwhitney@cabinets.com](mailto:cwhitney@cabinets.com)





Note: This drawing is an artistic interpretation of the general appearance of the design. It is not meant to be an exact rendition.

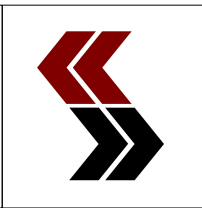

Designed: 2/17/2023  
Printed: 2/17/2023



Note: This drawing is an artistic interpretation of the general appearance of the design. It is not meant to be an exact rendition.

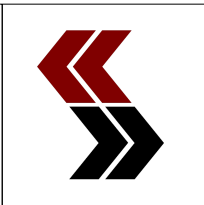

Designed: 2/17/2023  
Printed: 2/17/2023

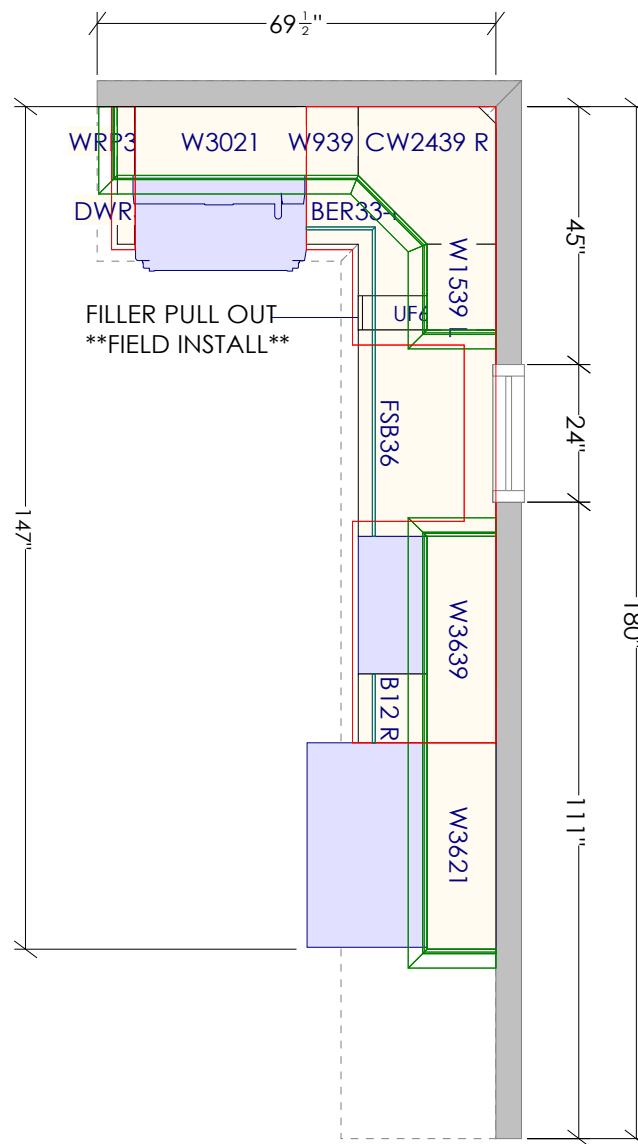
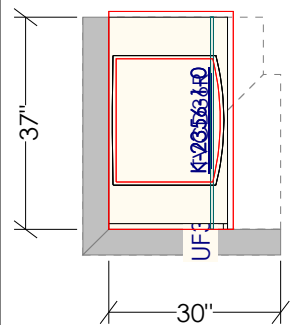

MAX KELLOGG - SACRAMENTO  
SHAKER II MAPLE BRIGHT WHITE  
FRAMED

CEILING HEIGHT: 96"

CABINET FINISH HEIGHT: 93" + 3" MOLDING STACK

WALL CABINETS TO BE MOUNTED AT 54" AFF

PLEASE VERIFY ALL WALL, WINDOW, DOOR, AND  
APPLIANCE DIMENSIONS PRIOR TO ORDERING.

**\*\*PRELIMINARY PLAN\*\***  
NOT CONSIDERED FINAL.

PLEASE VERIFY FINAL CABINET RUN

All dimensions and size designations given are subject to verification on job site and adjustment to fit job conditions.



This is an original design and must not be released or copied unless applicable fee has been paid or job order placed.

Designed: 2/17/2023  
Printed: 2/17/2023

BEP

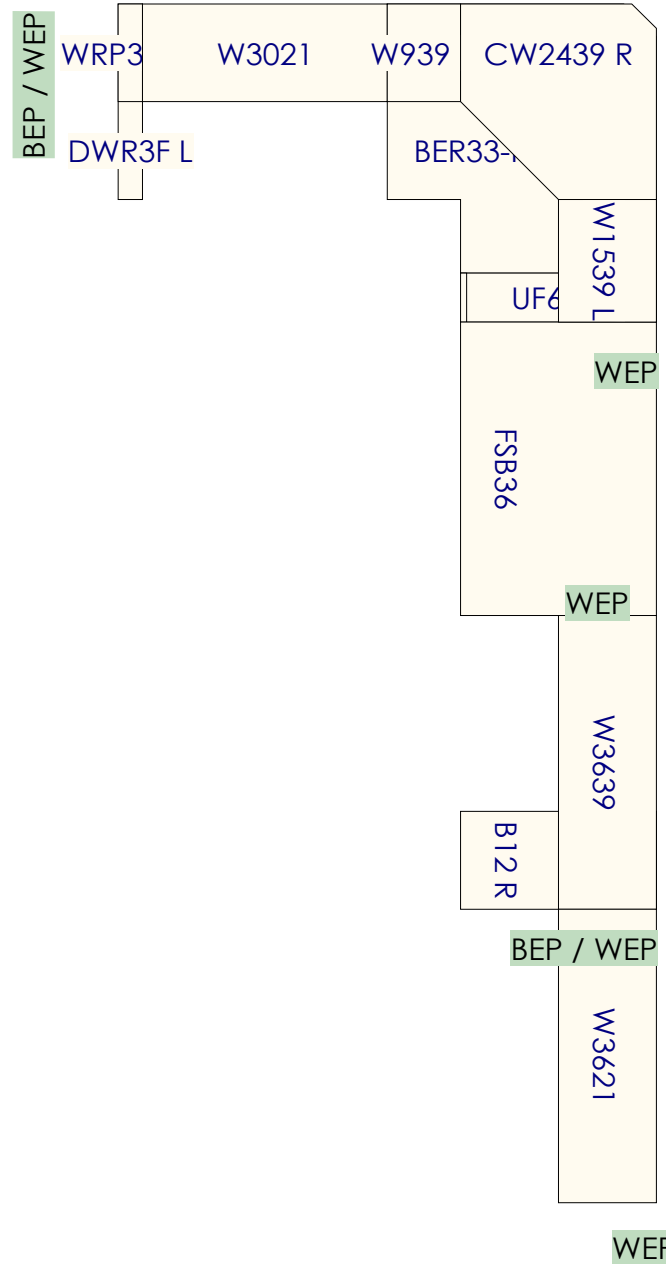
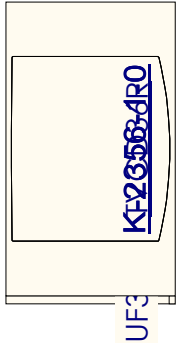

WEP

All dimensions and size designations given are subject to verification on job site and adjustment to fit job conditions.



This is an original design and must not be released or copied unless applicable fee has been paid or job order placed.

Designed: 2/17/2023  
Printed: 2/17/2023

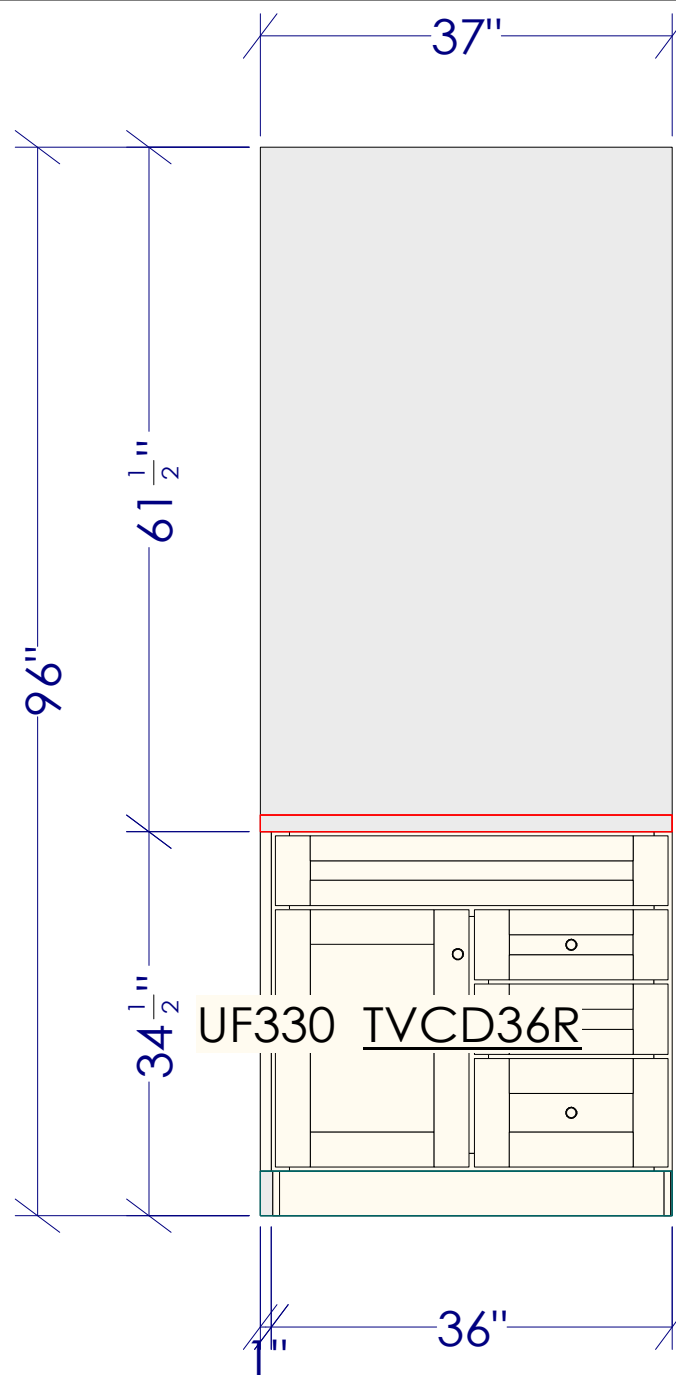

All dimensions and size designations given are subject to verification on job site and adjustment to fit job conditions.



This is an original design and must not be released or copied unless applicable fee has been paid or job order placed.

Designed: 2/17/2023  
 Printed: 2/17/2023

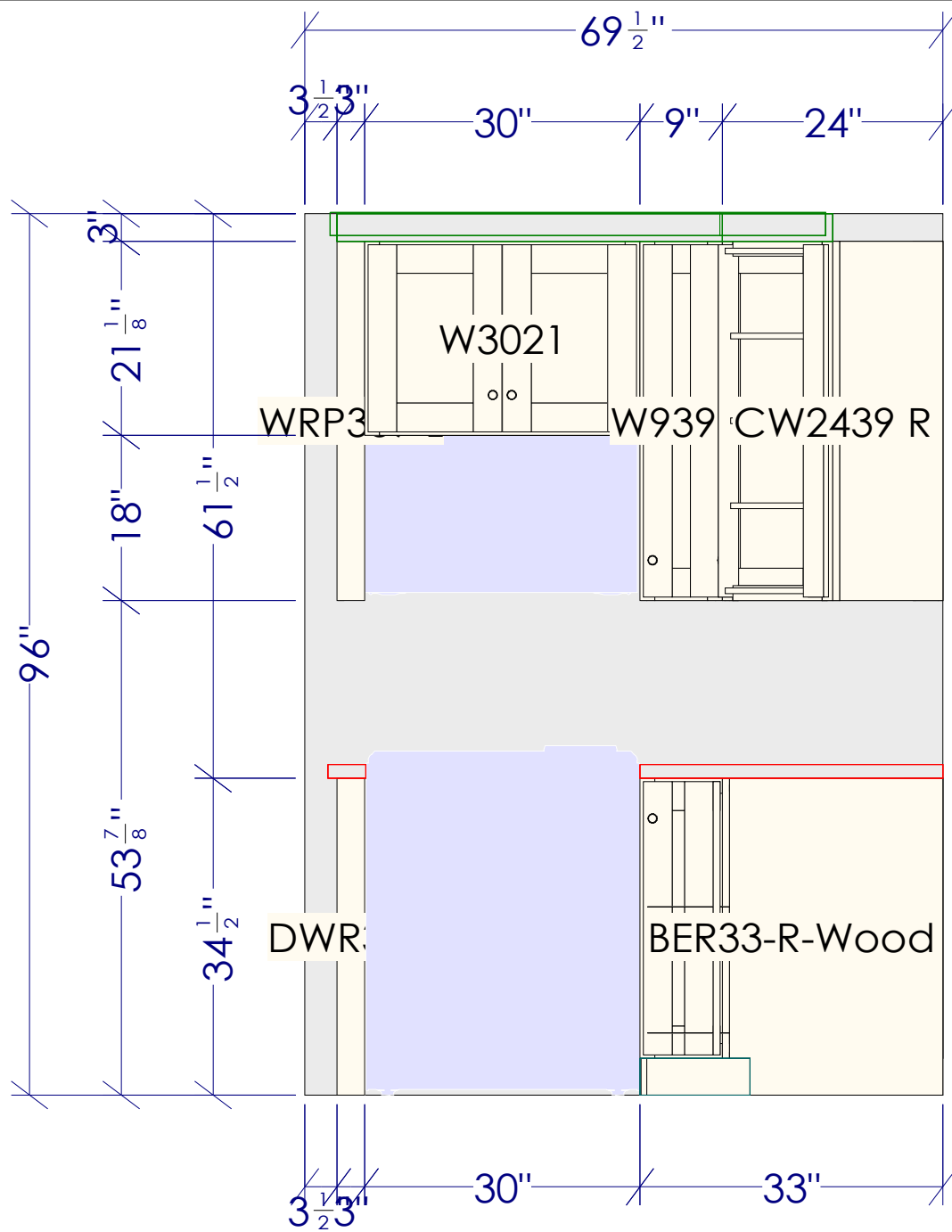

All dimensions and size designations given are subject to verification on job site and adjustment to fit job conditions.



This is an original design and must not be released or copied unless applicable fee has been paid or job order placed.

Designed: 2/17/2023  
 Printed: 2/17/2023

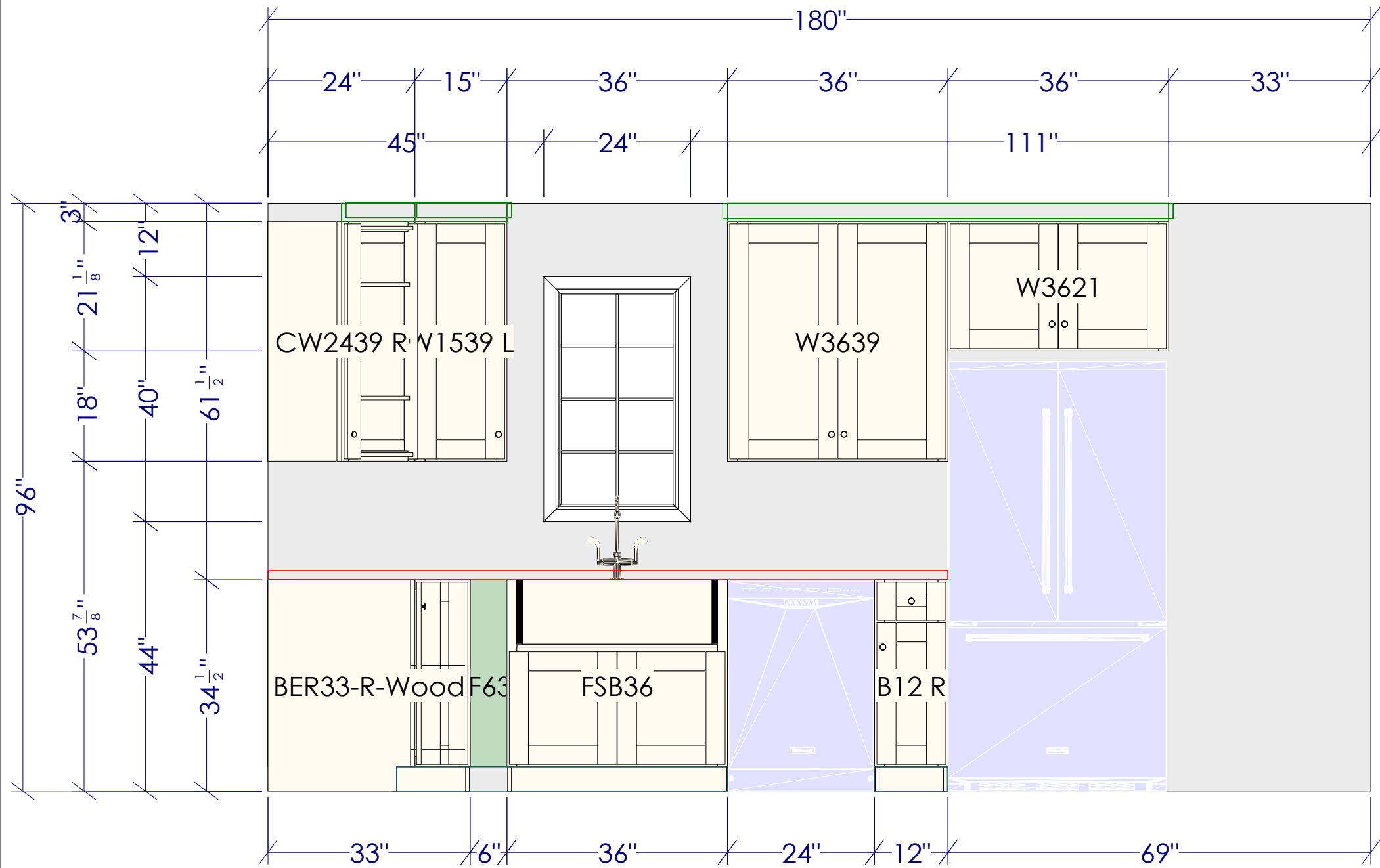

All dimensions and size designations given are subject to verification on job site and adjustment to fit job conditions.



This is an original design and must not be released or copied unless applicable fee has been paid or job order placed.

Designed: 2/17/2023  
 Printed: 2/17/2023



## DELIVERY IN:

**6 - 8 WEEKS**

At Cabinets.com, we are committed to delivering high-quality kitchen cabinets at industry-leading delivery time frames.

All qualifying orders will receive a final mile delivery service at no additional charge. Some restrictions may apply in select areas.

All Final-Mile deliveries will be scheduled for soonest available dates

For more shipping questions, please contact the [customer service](#) team.

## GENERAL INFORMATION

We recommend that cabinets be stored only in a clean, dry, climate-controlled environment. Most delivery facilities are not properly equipped for extended or long-term storage of real wood cabinetry. Storage options are not available for all Final-Mile deliveries.

Please prepare the space in which you would like the cabinets to be placed and be sure the area is dry and large enough to hold all items. Cabinets.com will ship all orders in the timeliest manner possible and is not responsible nor liable for any issues resulting from shipment delay of any kind.

Delivery personnel will not unpack the cabinets, however, if a cabinet appears to be damaged (box damage) you may ask to have that item removed from the packaging for further inspection.

Delivery constitutes ONE attempt at the scheduled time. If for any reason the customer is unable to accept the order at the designated time, the cost of subsequent delivery attempts would be the responsibility of the customer.

## WE'LL KEEP IN TOUCH

We will keep you informed about the delivery status of your order, communicating with you at the following points:

- An email from us when your order ships from the factory with a projected arrival date at the local delivery terminal.
- A call from the delivery company to schedule your in-home delivery appointment.
- An automated call one day prior to actual delivery to provide a four-hour delivery window.
- A call from delivery personnel thirty minutes to one hour prior to arrival.

## WHAT TO EXPECT UPON DELIVERY

- Box truck transportation
- Delivery into your room of choice on the ground floor of your home.
- Signature required by someone over 18 years of age.